

**FS Solutions**  
The best in flexible transportsystems

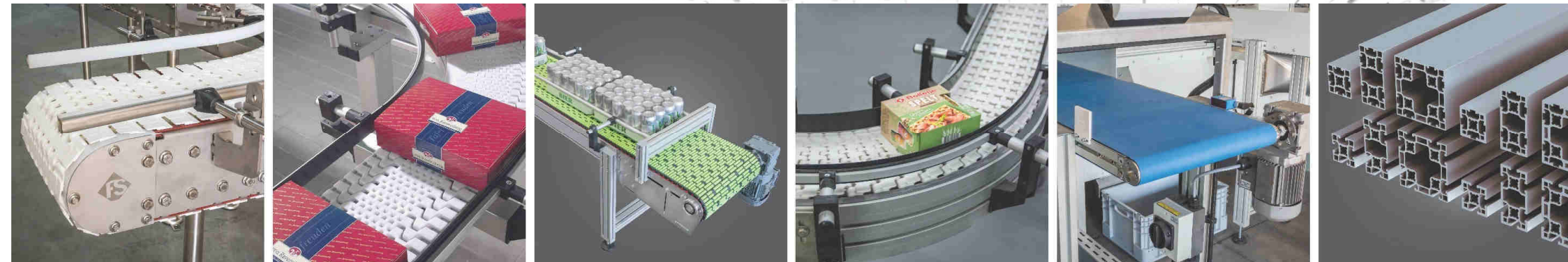

## Produkte und Industriezweige



The best in flexible transportsystems

## Transportlösungen aus Aluminium und Edelstahl

- ✓ Tausendfach bewährt in unterschiedlichsten Industriezweigen
- ✓ Durch den modularen Aufbau:
  - kurze Lieferzeiten
  - einfach zu realisieren
  - anzupassen an zukünftige Anforderungen
- ✓ Komponenten, Förderer und schlüsselfertige Anlagen
- ✓ Kompetent, schnell und zuverlässig

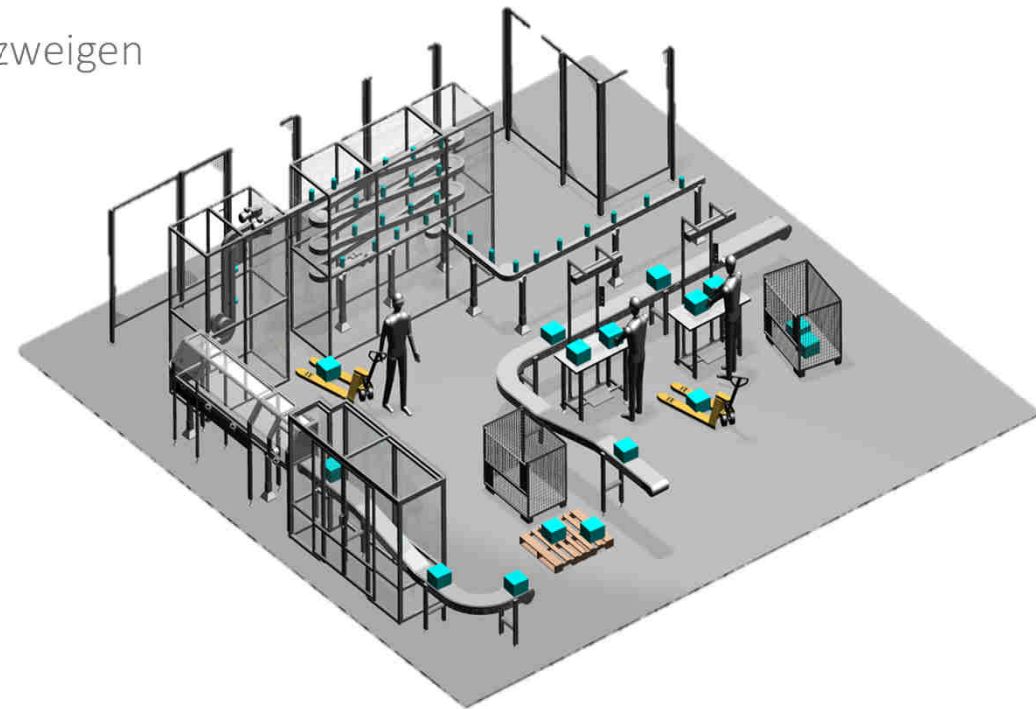

**FS Solutions**  
The best in flexible transportsystems



**FS Solutions GmbH**  
The best in flexible transportsystems



**FT SOLUTIONS**

**PS NEDERLAND**  
industrial power & control

- Stretch Line Gliederbandkette
- MTS – Mattenkette – geradgängig
- MTC – Mattenkette – kurvengängig
- Rollenförderer
- BC Gurtförderer
- FS Gripper- Klemmförderer
- Aluminium- Profilsystem

Lebensmittelindustrie

Tabakindustrie

Pharmaindustrie

Konsumgüterindustrie

Logistik

diverse Industriezweige

**VANDERLANDE**

vanderlande.com

MOVING YOUR BUSINESS FORWARD



**JTI**



**MEYER&MEYER**  
since 1902



**PEPSICO**

**SEW**  
EURODRIVE



**Mondelēz**  
International







## Gliederbandketten- System CS-SL

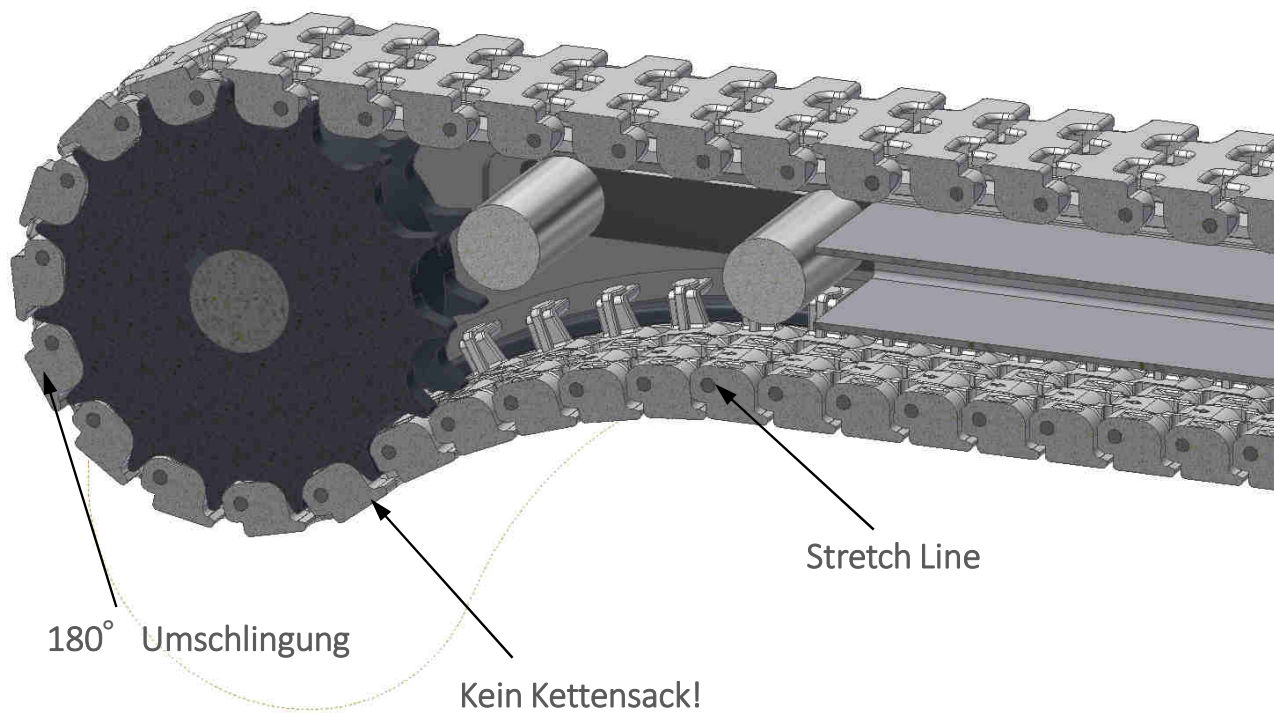

## Gliederbandketten- System CS-SL

- ✓ Kein Kettensack erforderlich → weniger Wartung
- ✓ Modular → einfache Anwendung
  - bei Änderung flexibel anpassbar
  - vielseitig erprobt und zuverlässig
- ✓ Kompaktes Design → spart Platz in der Produktion
- ✓ Niedriger Reibwert → energiesparend
- ✓ Umfangreiches Ketten und Zubehörprogramm



## Gliederbandketten- System CS-SL



## Mattenkettenförderer- System FS-MTS-100.ALU

- ✓ Geradgängiger Transport
- ✓ Hohe Zugkräfte
- ✓ Breiten von 160 mm bis 1220 mm

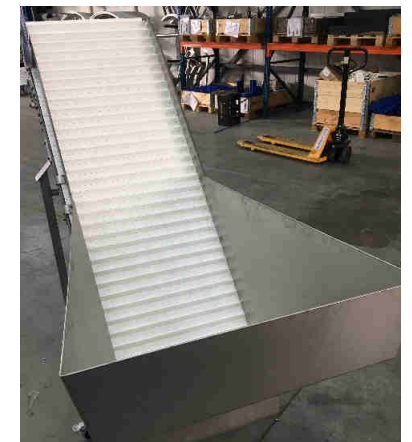
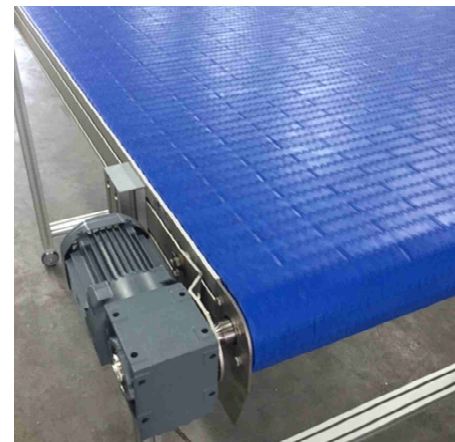



## Mattenkettenförderer- System FS-MTS-100.ALU





## Mattenkettenförderer- System FS-MTS-100.ALU

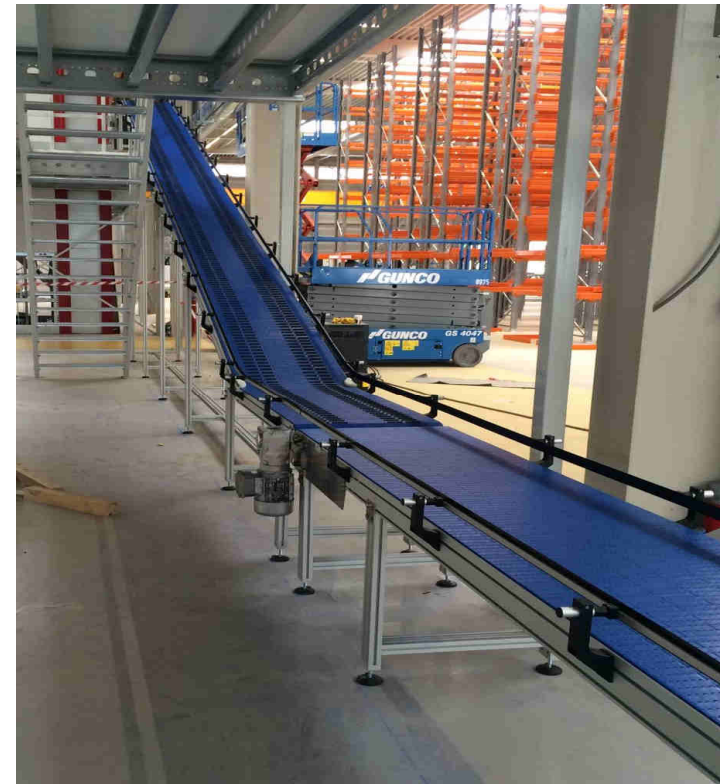
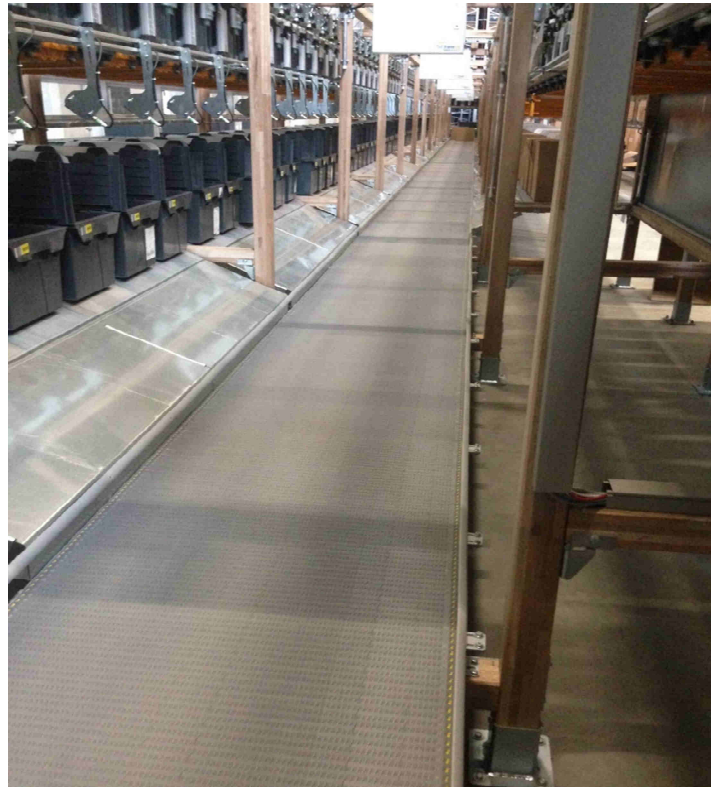

## Mattenkettenförderer- System FS-MTS-100.ALU

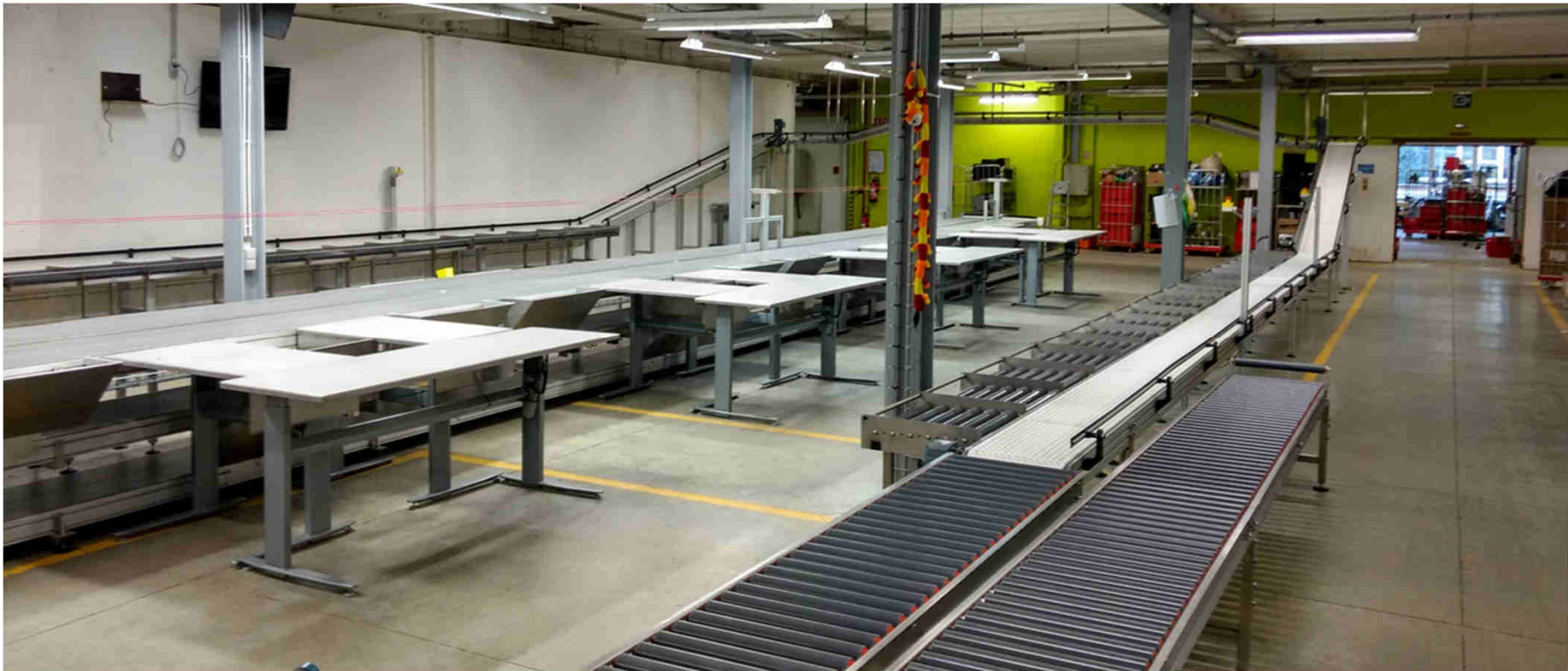

## Mattenkettenförderer- System FS-MTS-100.ALU





## Mattenkettenförderer für Staubetrieb FS-MTS-100.H mit LPB

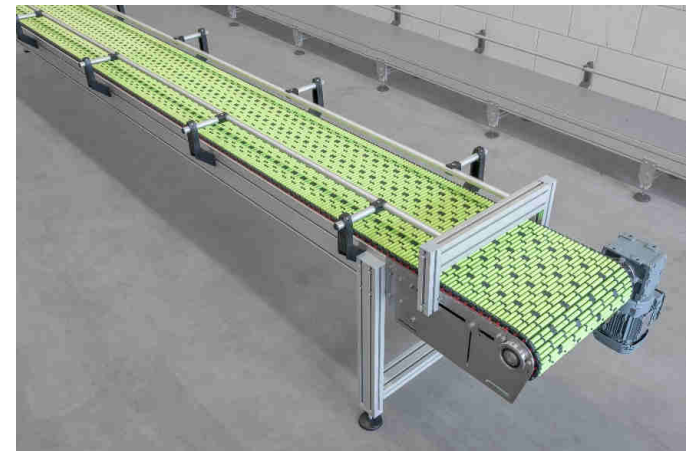
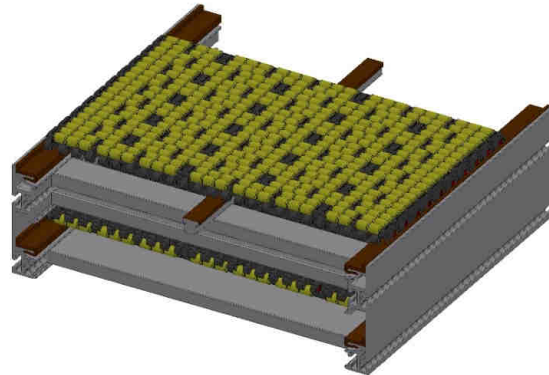
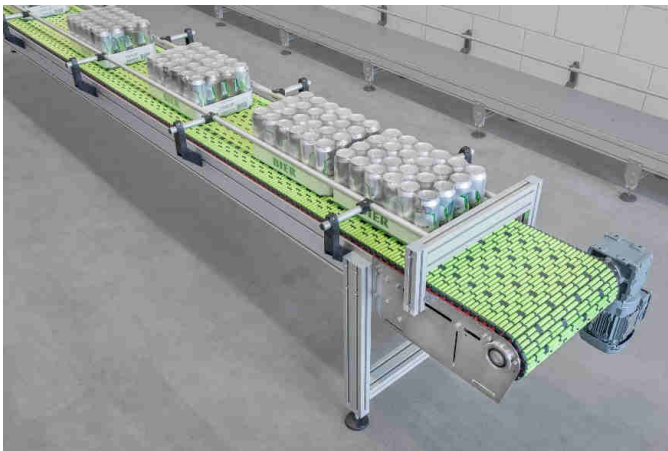

# Mattenkettenförderer- System kurvengängig FS-MTC-150.ALU/ 150.INOX

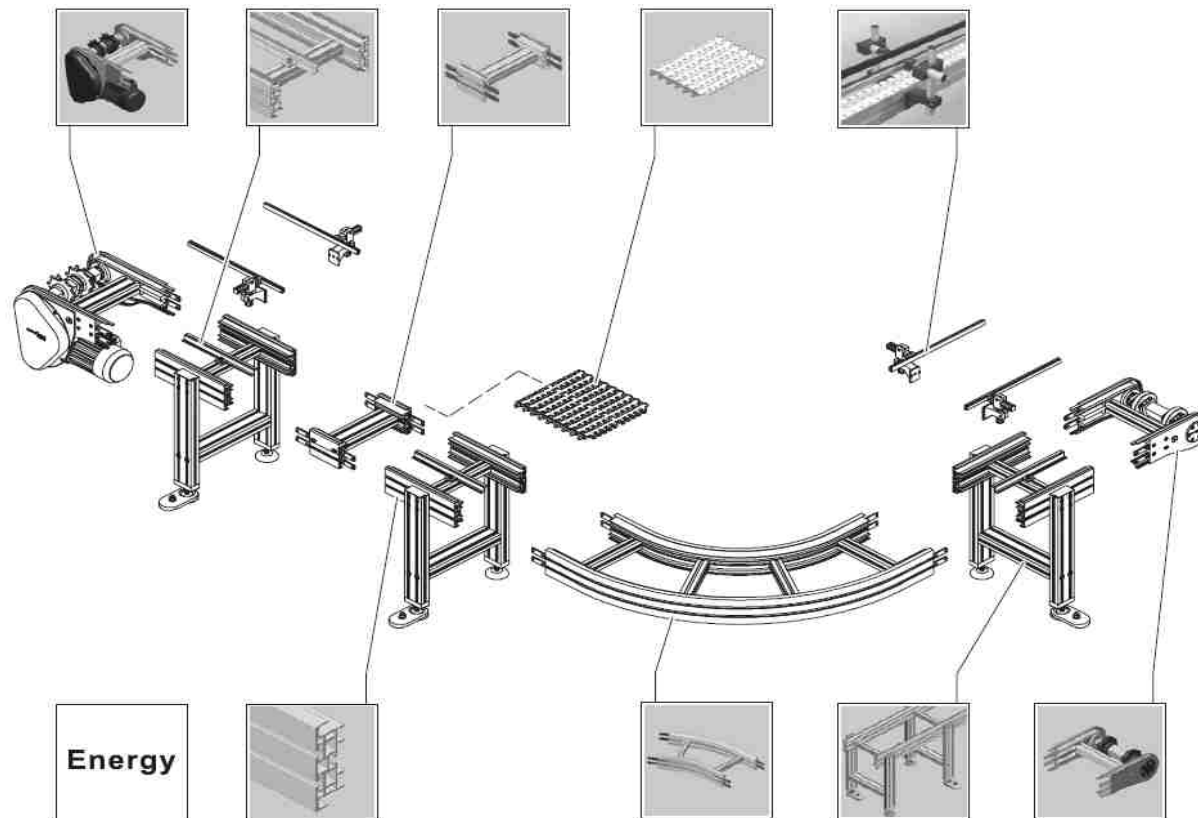



## Mattenkettenförderer- System kurvengängig FS-MTC-150.ALU/ 150.INOX

- ✓ kurvengängige (3D) Kette
- ✓ Breiten von 216 bis 635 mm
- ✓ Mitnehmer und Reibbeläge
- ✓ Keine Stahlbolzen
  - ➔ hohe Zugkräfte, geringes Eigengewicht
- ✓ ULF Gleitleiste für höchste Energieeffizienz



## Mattenkettenförderer- System kurvengängig FS-MTC-150.ALU/ 150.INOX

- Schnelle und einfache Montage
- Energiesparend, niedriges Gewicht
- Kleiner Biegeradius
- Auch mit hochverschleißfesten Führungsbolzen
- Geräuscharm

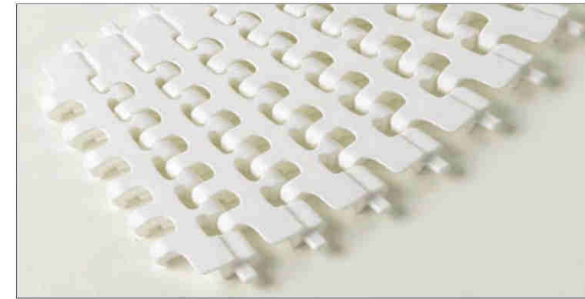
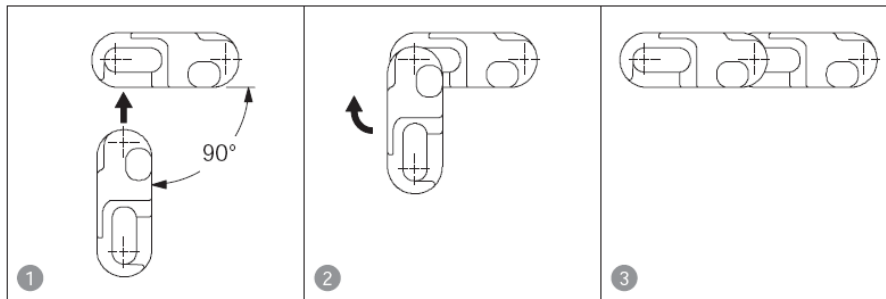

## Mattenkettenförderer- System kurvengängig FS-MTC-150.ALU/ 150.INOX



## Mattenkettenförderer- System kurvengängig FS-MTC-150.ALU/ 150.INOX





## Mattenkettenförderer- System kurvengängig FS-MTC-150.ALU/ 150.INOX





## Mattenkettenförderer- System kurvengängig FS-MTC-150.ALU/ 150.INOX

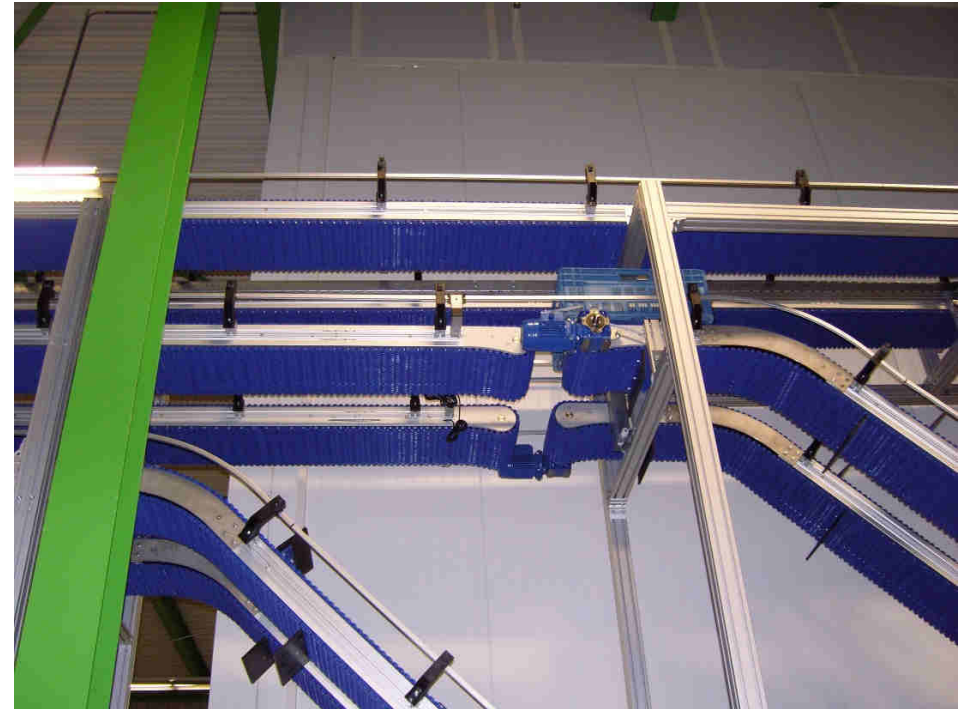

## Rollenförderer

- ✓ Stahl- und Kunststoffrollen
- ✓ Angetrieben und Schwerkraftrollenförderer
- ✓ Vielseitige Möglichkeiten für alle Lastbereiche

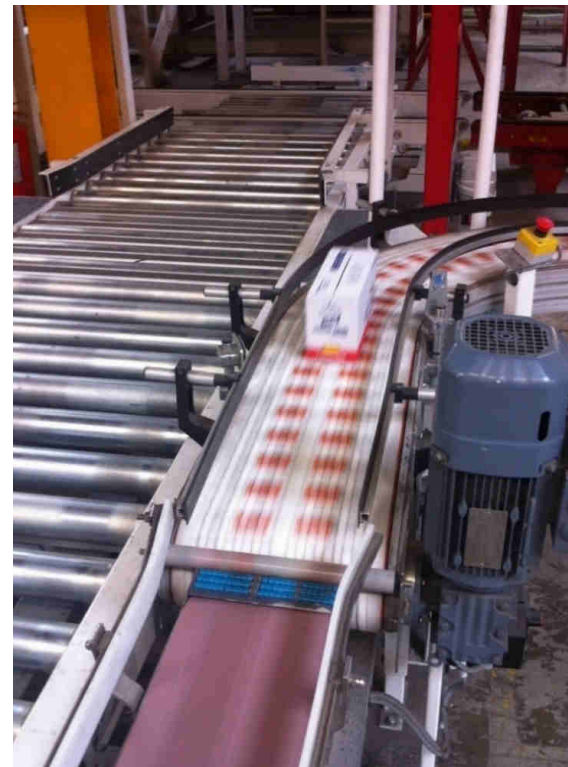

## Rollenförderer



## Gurtförderer

- ✓ Wahlweise Alu oder Edelstahl
- ✓ PVC und PU Gurte lieferbar
- ✓ Bauhöhe 40 mm für leichte Produkte
- ✓ Bauhöhe 80 mm für schwerere Produkte
- ✓ Laufruhig und langlebig
- ✓ Kundenspezifische Lösungen ergänzen das System der Standardförderer

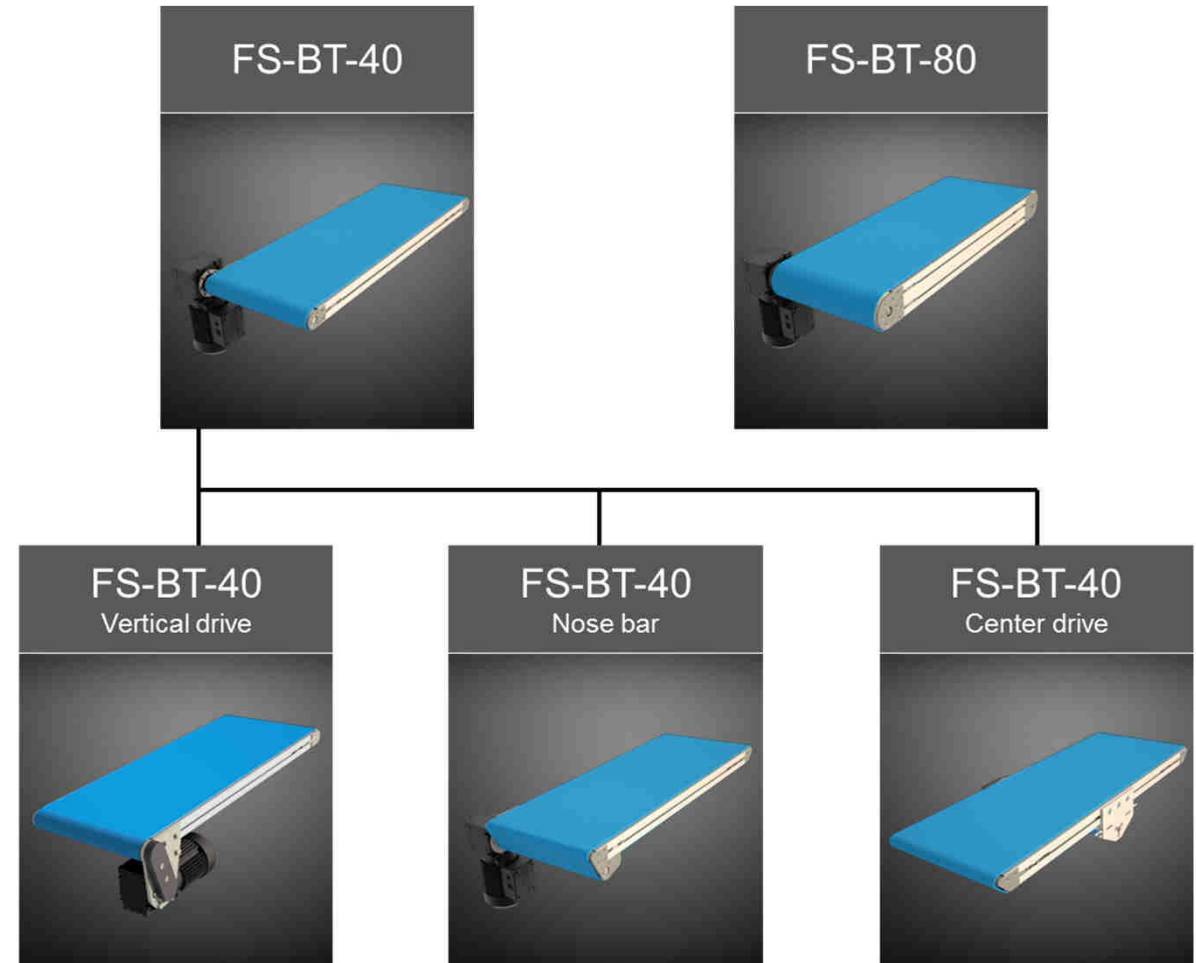



## Gurtbandförderer

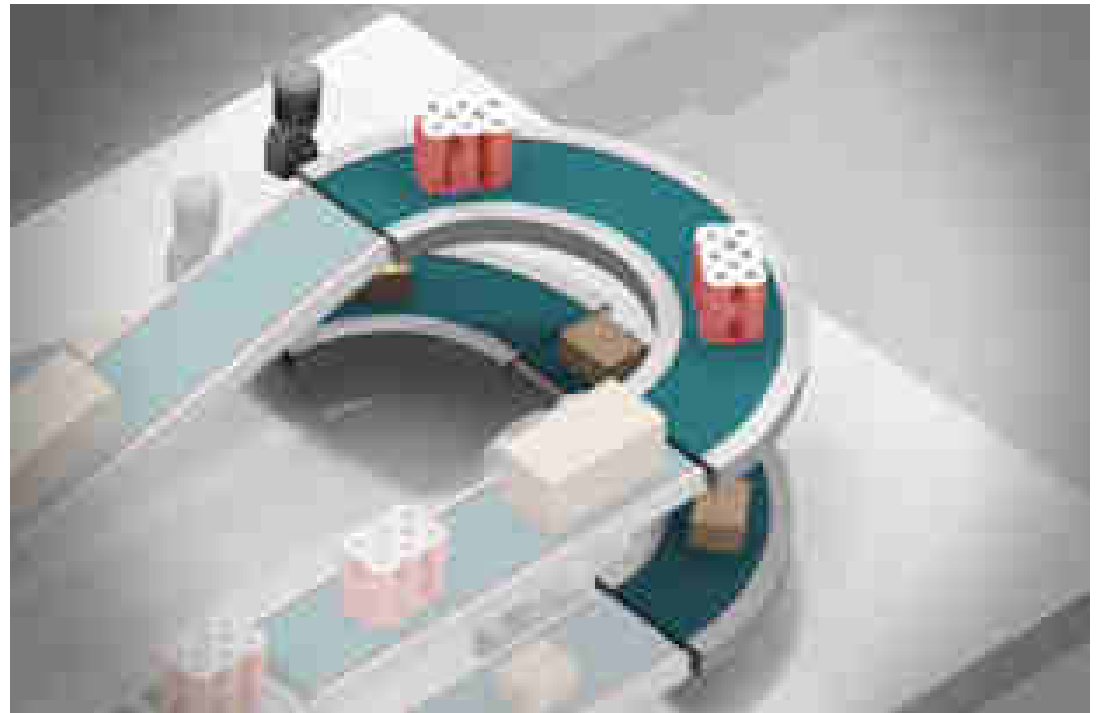



## Gripper - Klemmförderer Aluminium und INOX

- ✓ Gliederbandkette (3D)
- ✓ Breite 65 und 90mm
- ✓ Klemmelemente für leichte und schwere Produkte bis 10Kg
- ✓ Hohe Durchsatzmengen, platzsparend und zuverlässig

### Einsatzbereiche

- ✓ anheben/ absenken, z.B. vom Erdgeschoß in die 1. oder 2. Etage
- ✓ drehen der Produkte um beliebige Winkel

## Gripper - Klemmförderer Alu. CS090SL

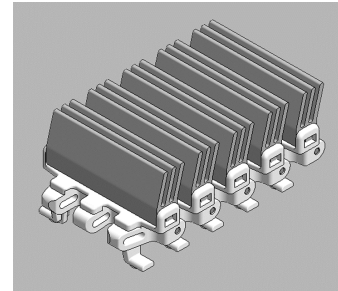
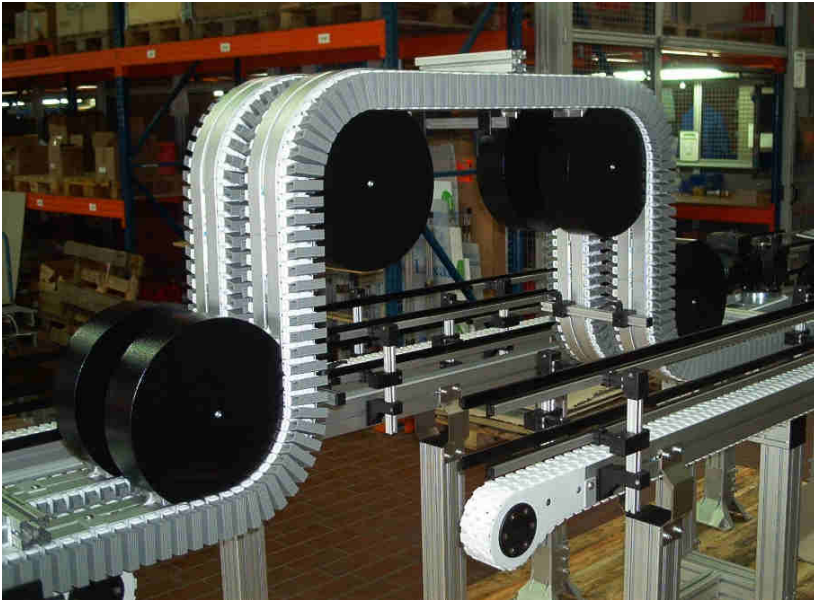

CS090SL Gripper  
Kette Form A

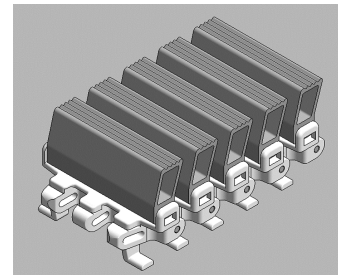

CS090SL Gripper  
Kette Form B

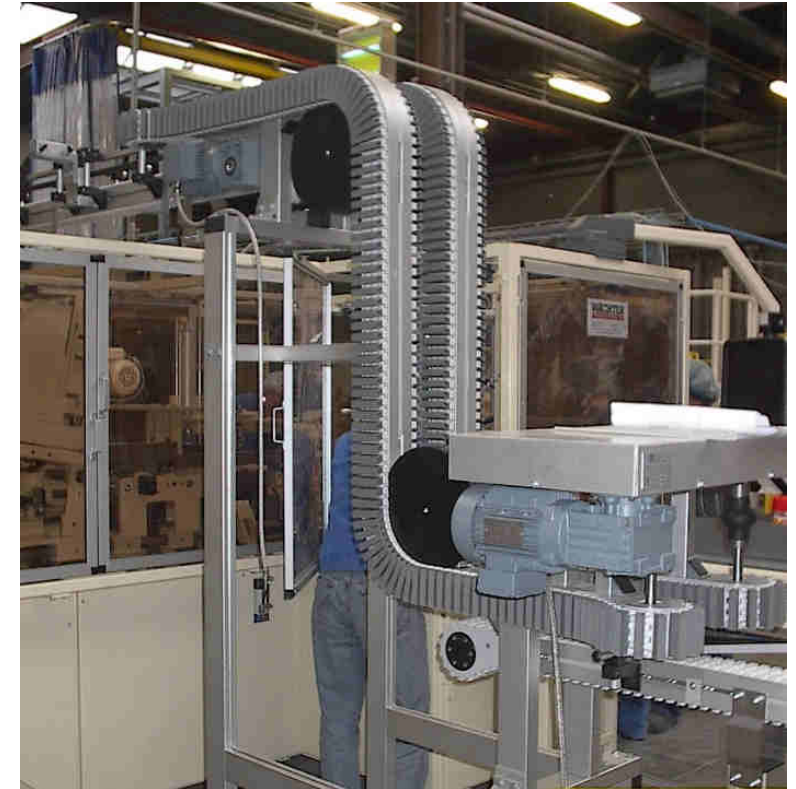

## Gripper – Klemmförderer Alu. CS090SL

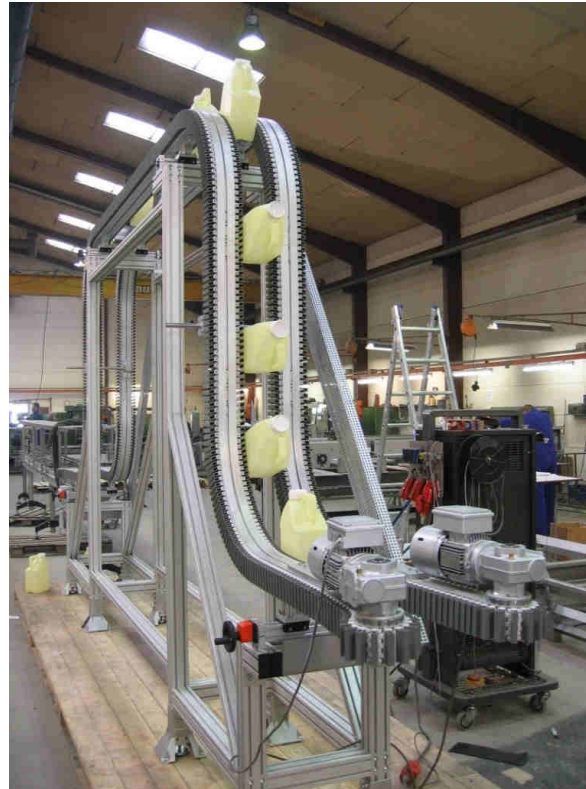
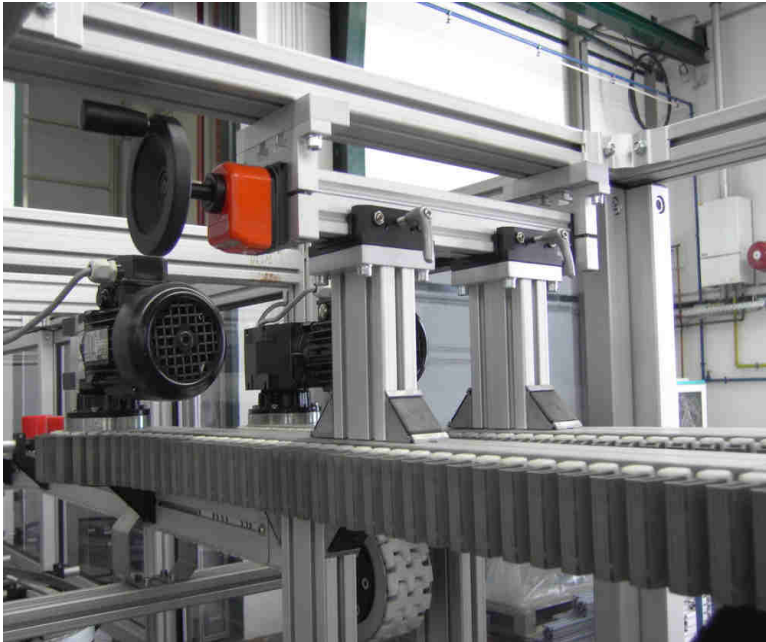

## Gripper – Klemmförderer CS090SL.INOX





## Einleitung Aluminium- Profilsystem

- ✓ Geschlossene und offene Profile (T-Nut)
- ✓ Rastermaße 20, 30, 40 und 50mm
- ✓ Umfangreiches Zubehör
- ✓ Sonderprofile nach Kundenwunsch

### Anwendungsbereiche

- ✓ Maschinenverkleidungen auch für höchste Ansprüche
- ✓ Gestelle
- ✓ Zäune
- ✓ und vieles mehr...

# Aluminium- Profilsysteme

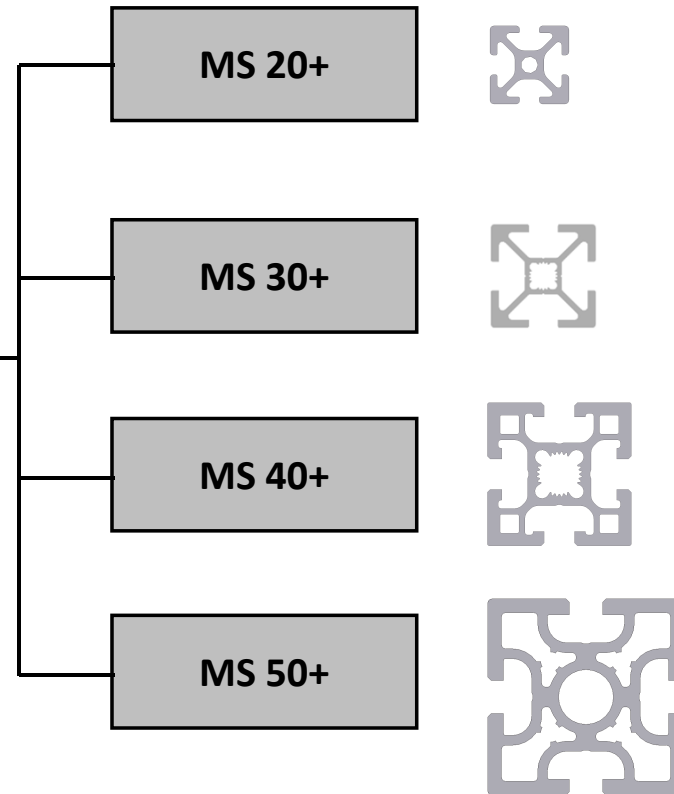
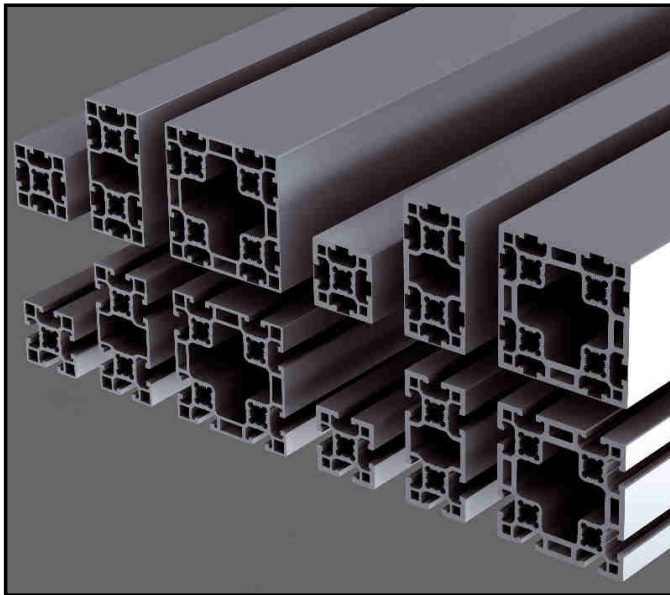

## Projekte – Aluminium Profilsystem



## Projekte – Aluminium Profilsystem

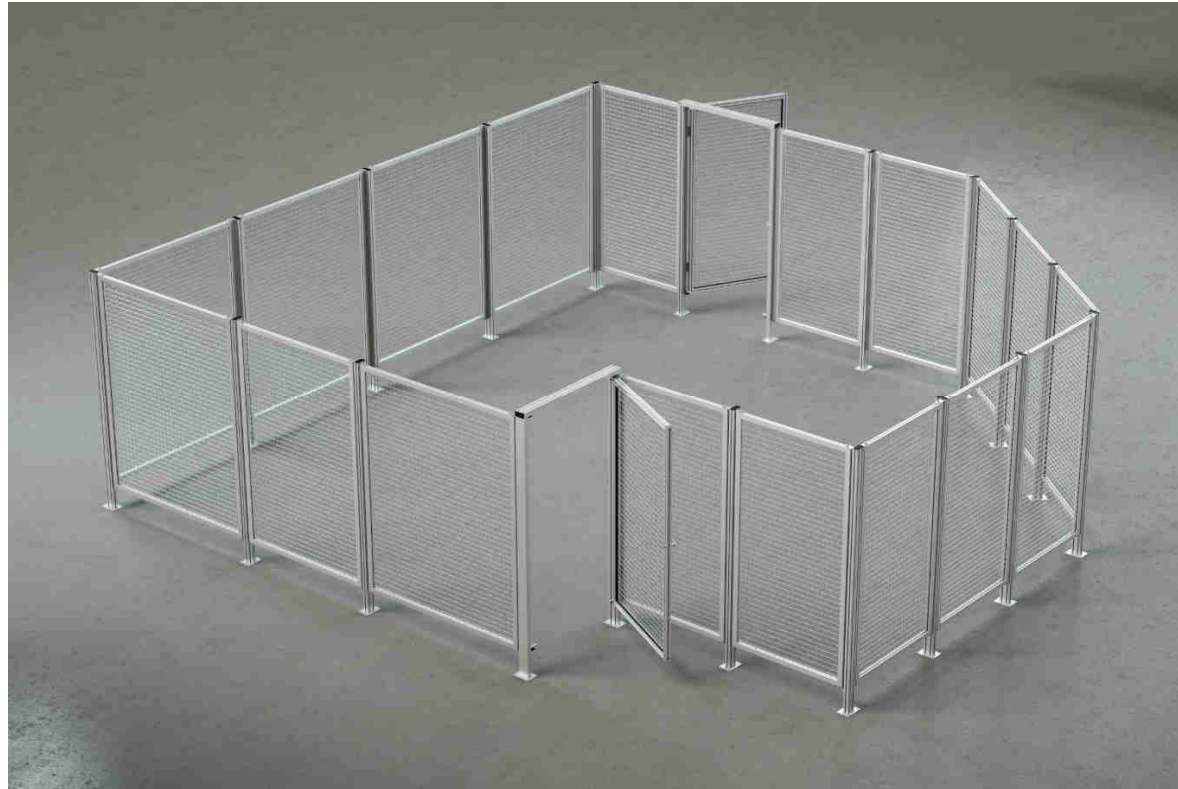



## FS- Lebensmittelindustrie



## FS- Lebensmittelindustrie



## FS- Lebensmittelindustrie

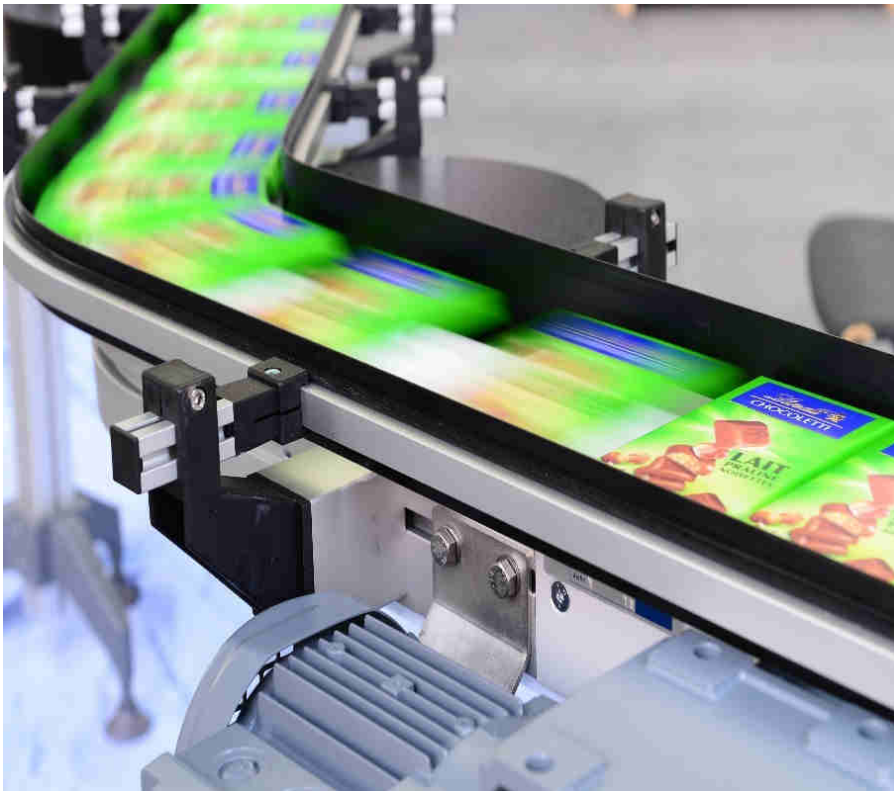



## FS- Lebensmittelindustrie





## FS- Lebensmittelindustrie



## FS- Lebensmittelindustrie





## FS- Lebensmittelindustrie



## FS- Lebensmittelindustrie





## FS- Lebensmittelindustrie

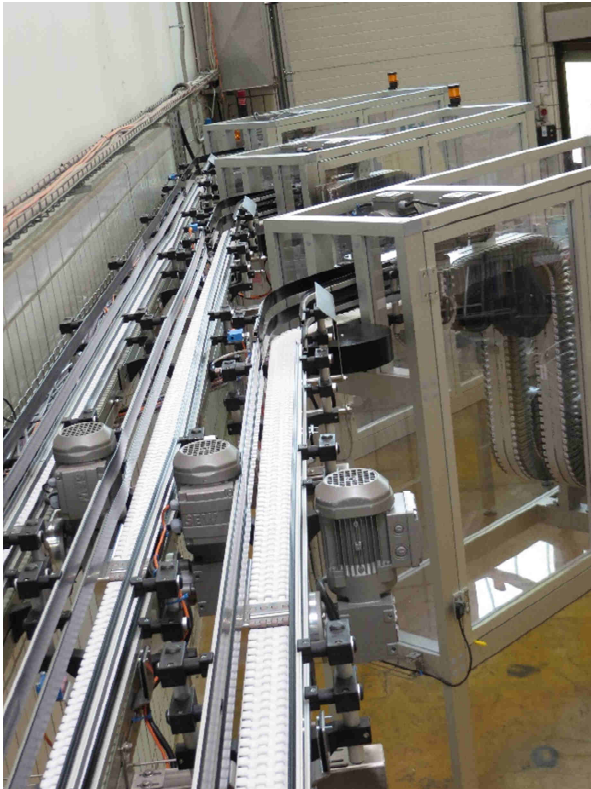

## FS- Lebensmittelindustrie



## FS- Lebensmittelindustrie Edelstahl





## FS- Lebensmittelindustrie Edelstahl

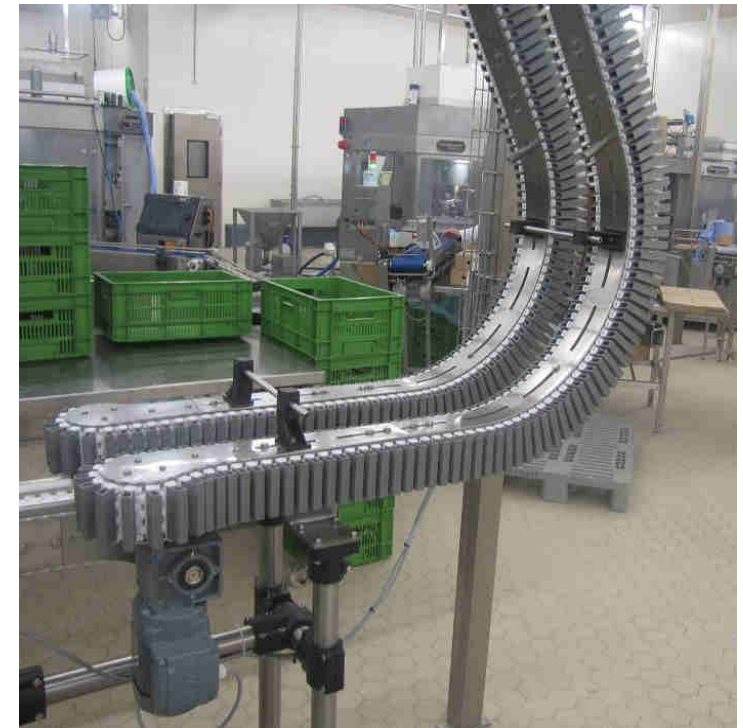



## Beispiele realisierter Projekte „Lebensmittelindustrie“:



## FS- Tabakindustrie



## FS- Tabakindustrie





## FS- Tabakindustrie

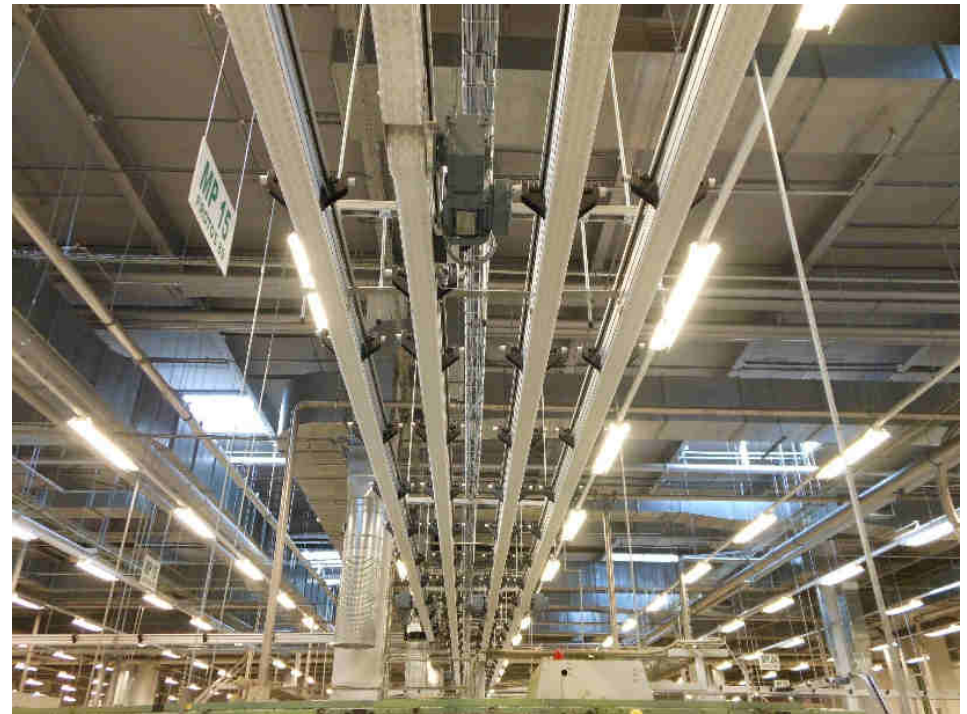



# Chain CS065SL Filter Art. Nr. 400013

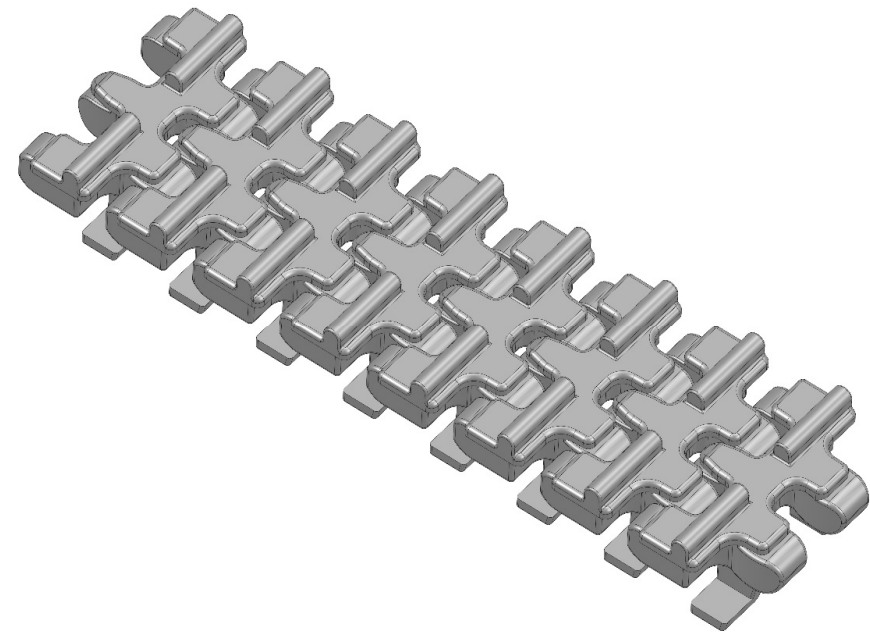
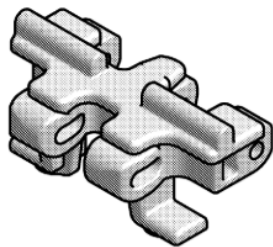
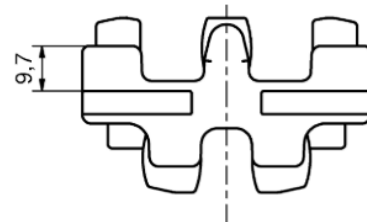
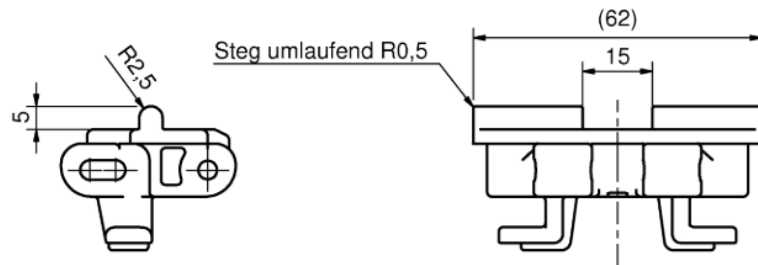

Alle übrigen Maße siehe Artikel 534550

## Filter Transport



## Beispiele realisierter Projekte „Tabakindustrie“:



## FS- Pharmaindustrie





## FS- Pharmaindustrie



## FS- Pharmaindustrie

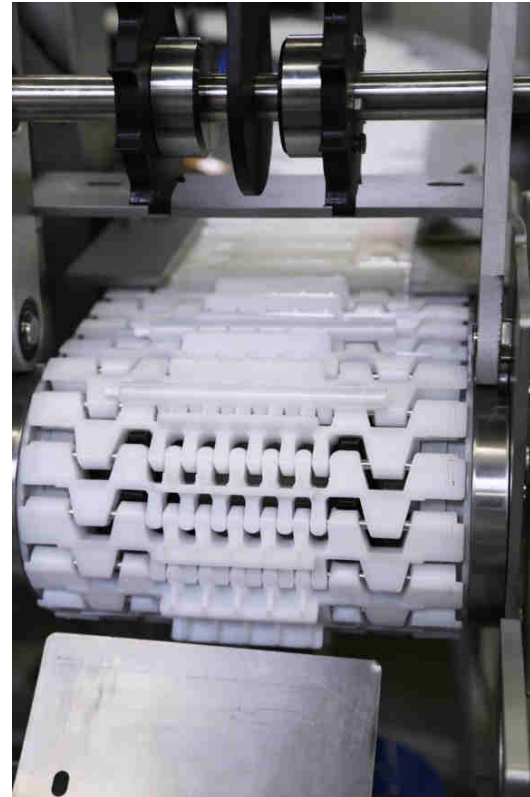

## FS- Konsumgüterindustrie



## FS- Konsumgüterindustrie

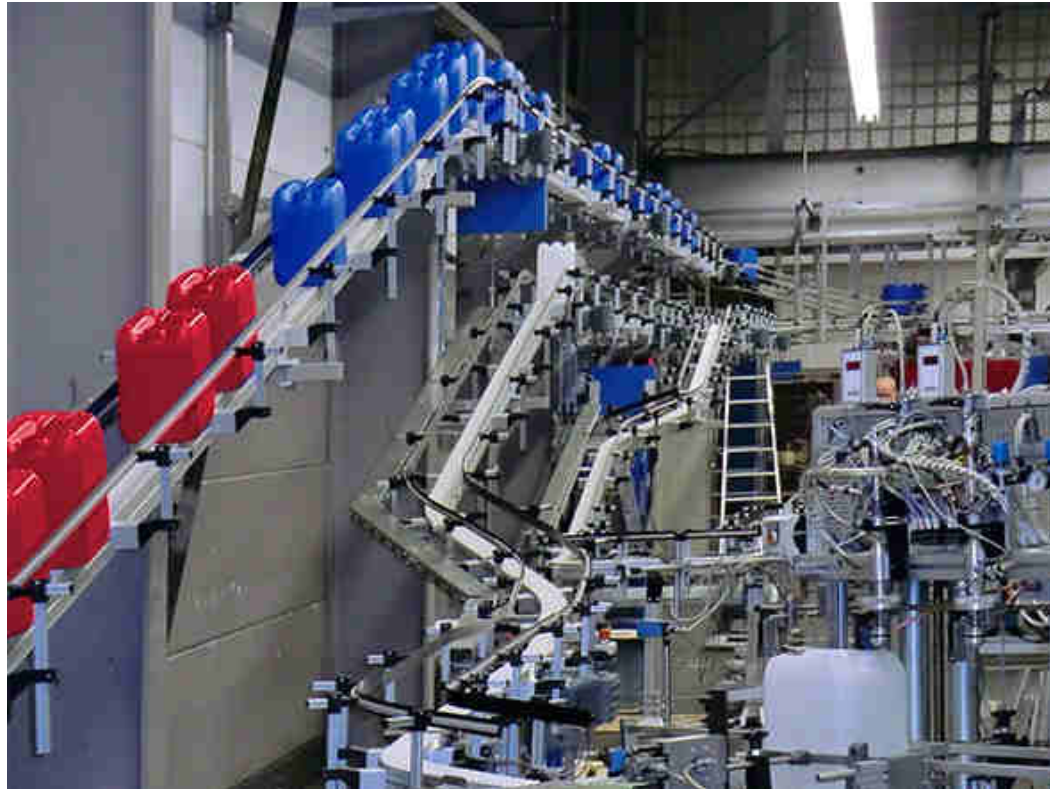

The best in flexible transportsystems



## FS- Konsumgüterindustrie

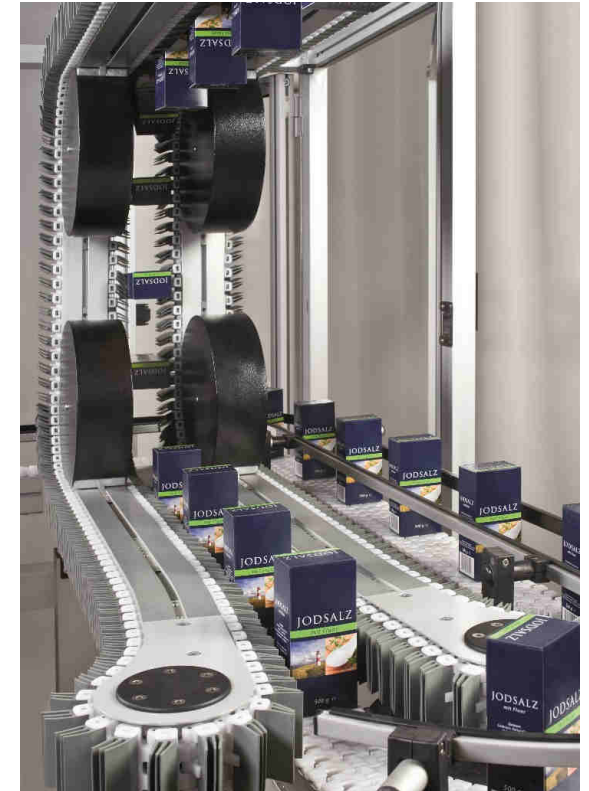

## FS- Konsumgüterindustrie

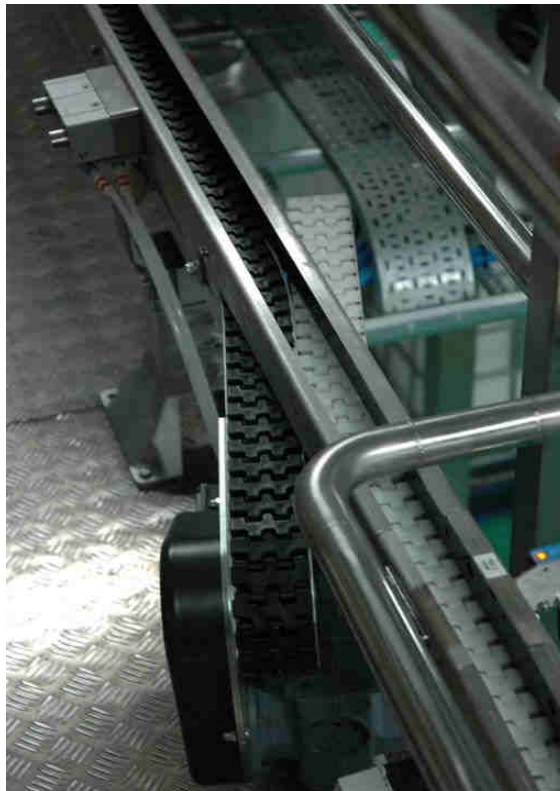

## Beispiele realisierter Projekte „Konsumgüterindustrie“:

BDF ●●●●  
Beiersdorf

P&G

  
*A Brand like a friend*

 **FAMAR**  
HEALTH CARE SERVICES

  
Unilever

## Logistik-Projekte

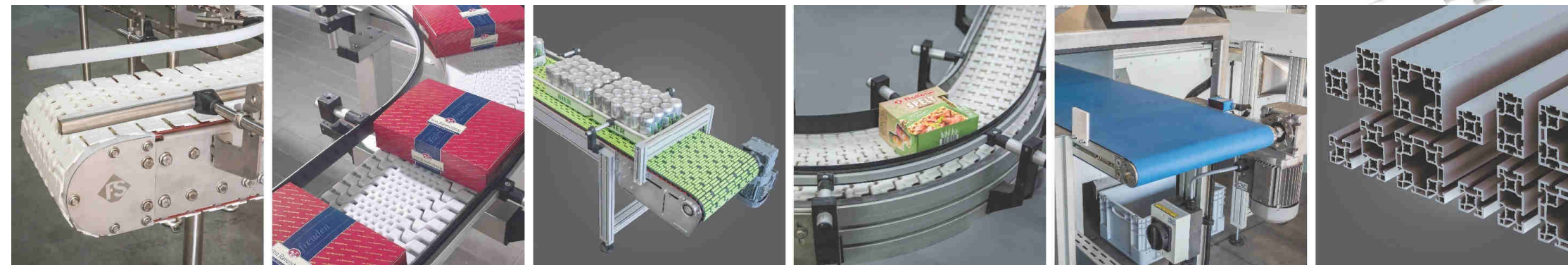



## FS- Mattenkettenförderer kurvengängig FS-MTC-150

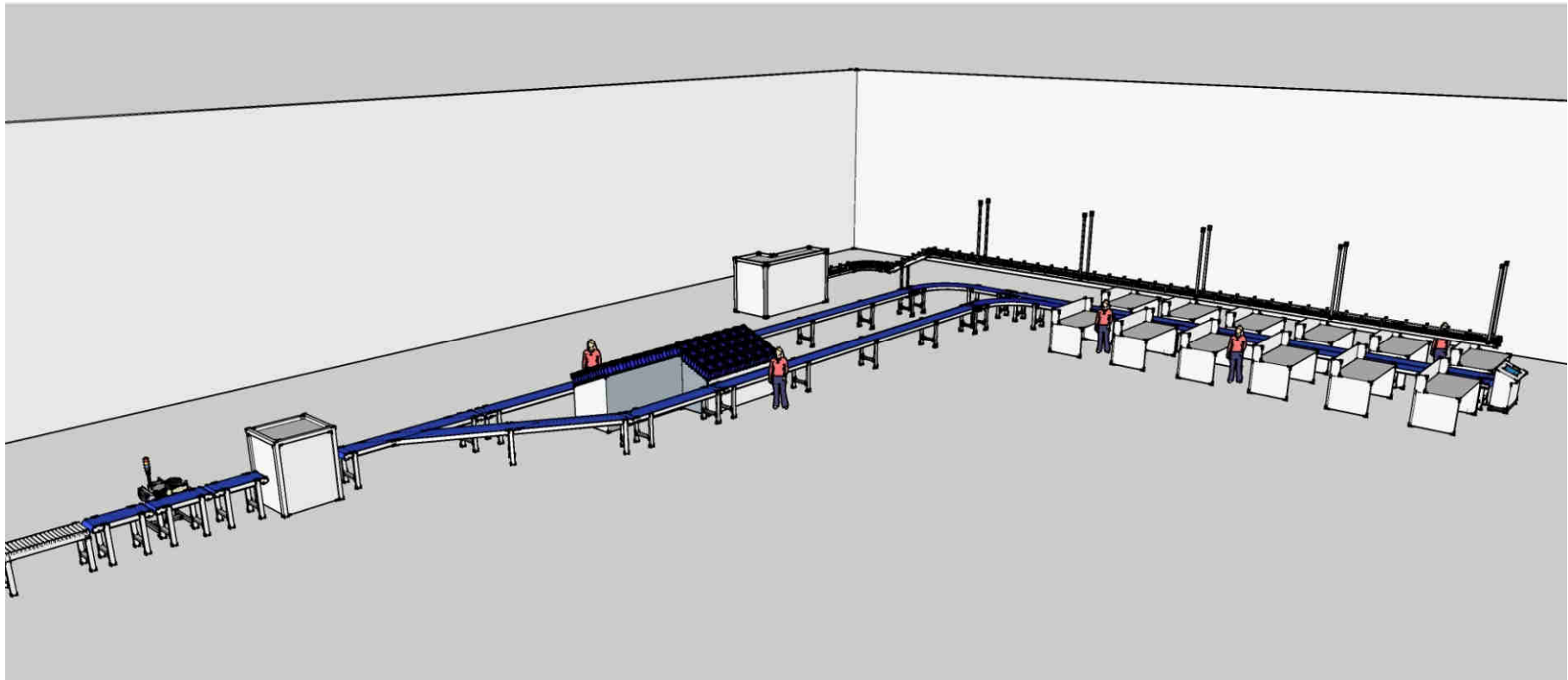

## FS- Rollenförderer

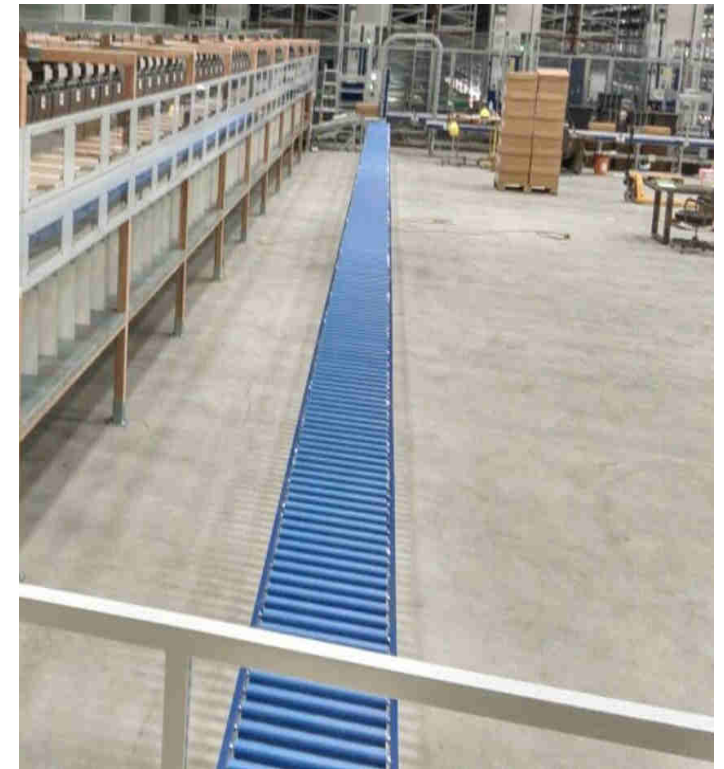

## FS- Rollenförderer



## Sortieren und verteilen

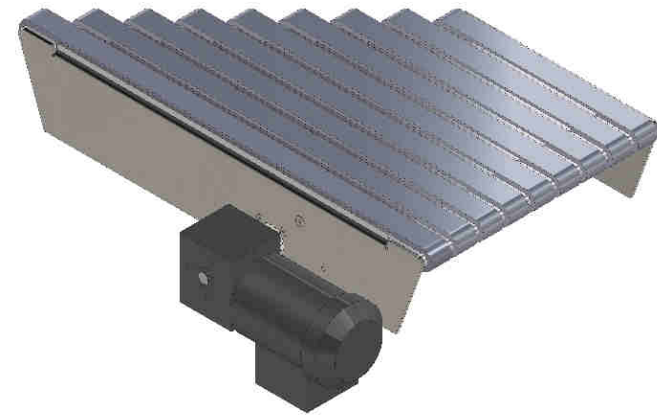
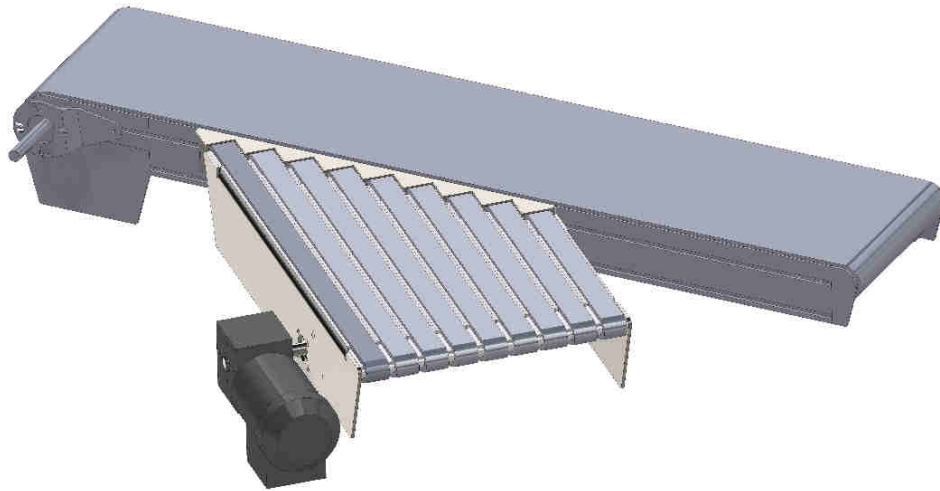



## Sortieren und verteilen

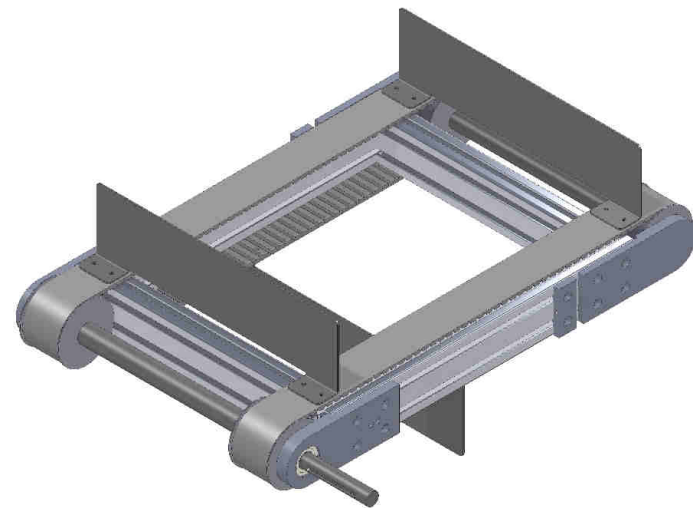
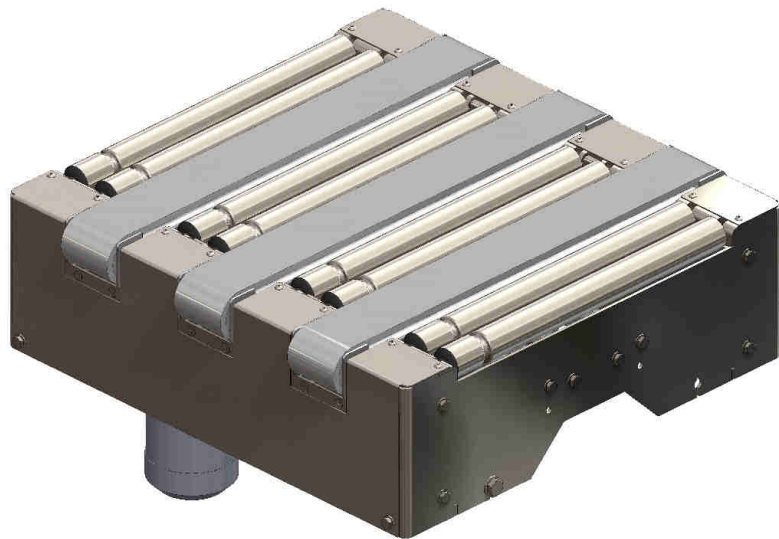

## Sortieren und verteilen

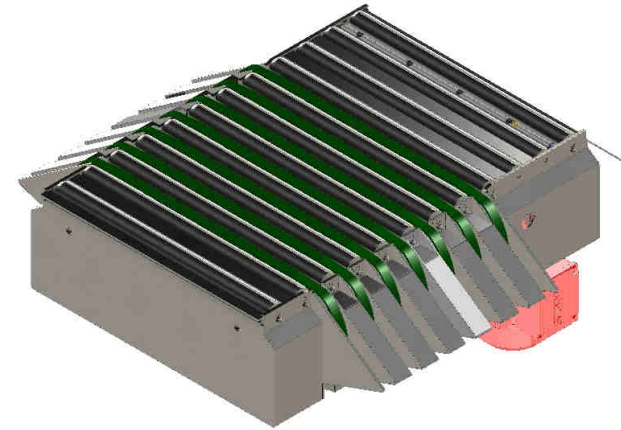
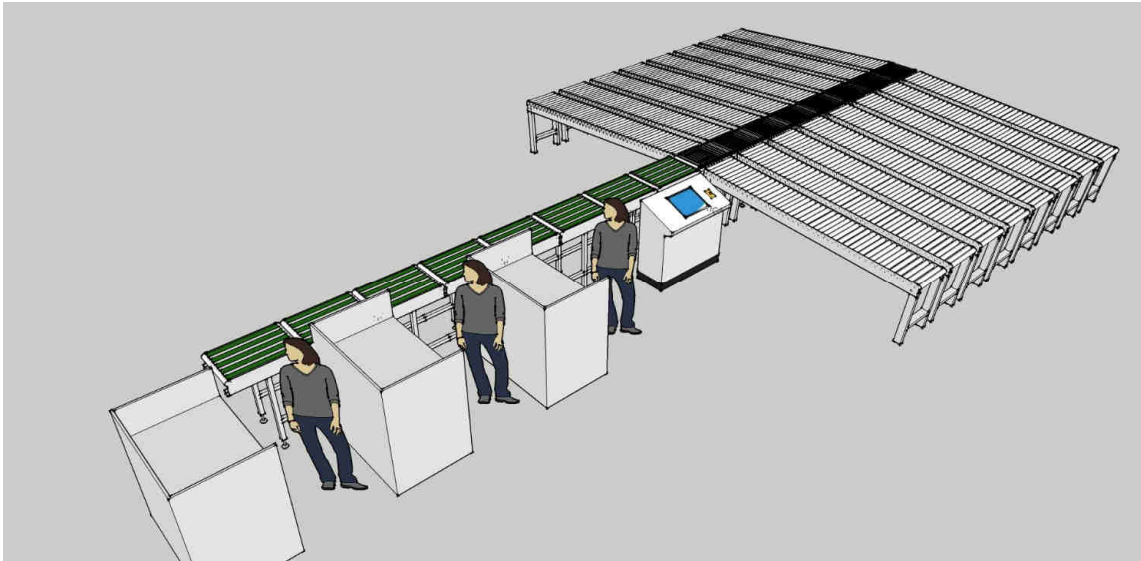

## Transport von Kisten

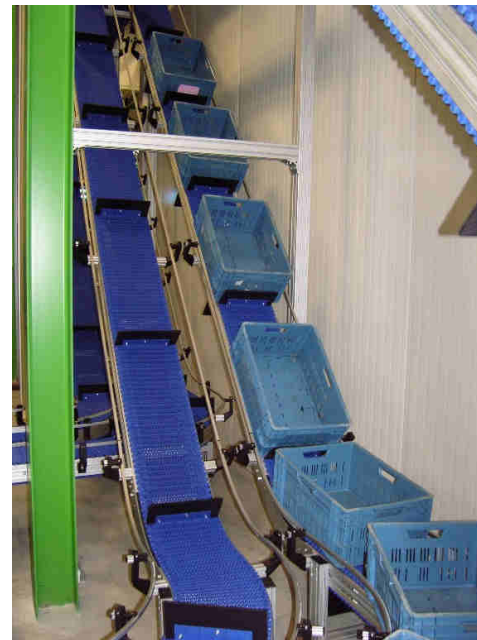

## Palettentransport

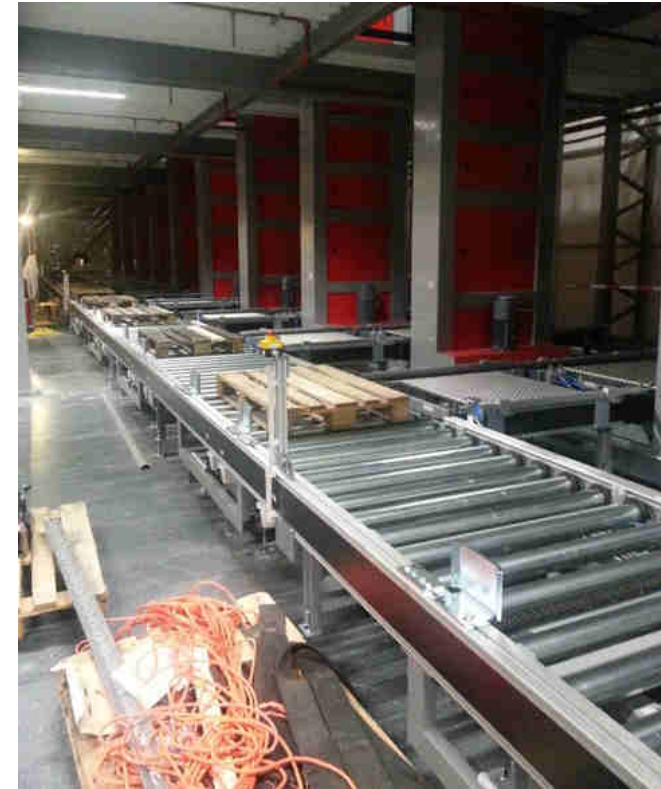



# Palettentransport



# Projektlösungen



## Beispiele realisierter Projekte Logistik:



## FS- Maschinenbau

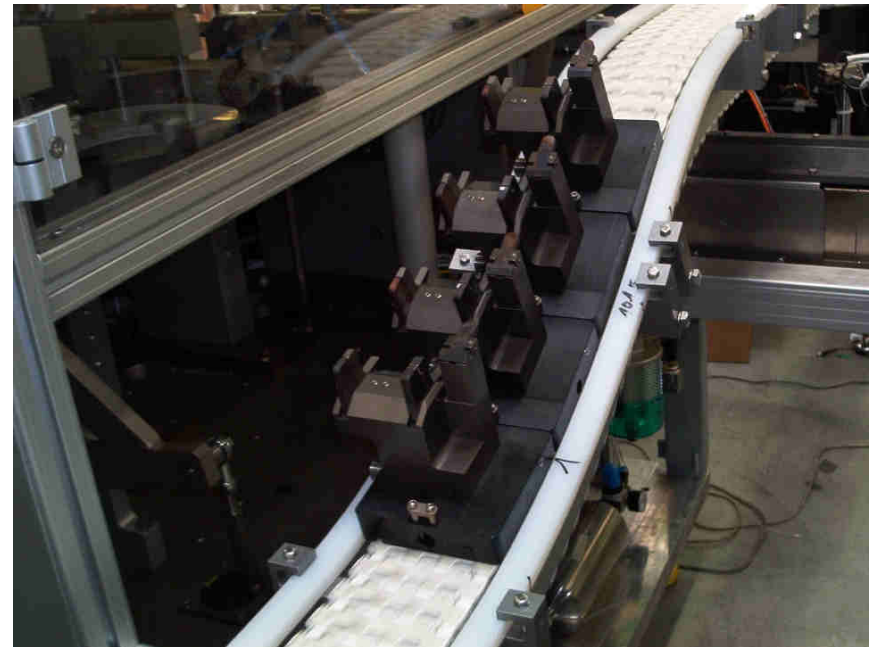



## FS- Maschinenbau



## FS- WT-System

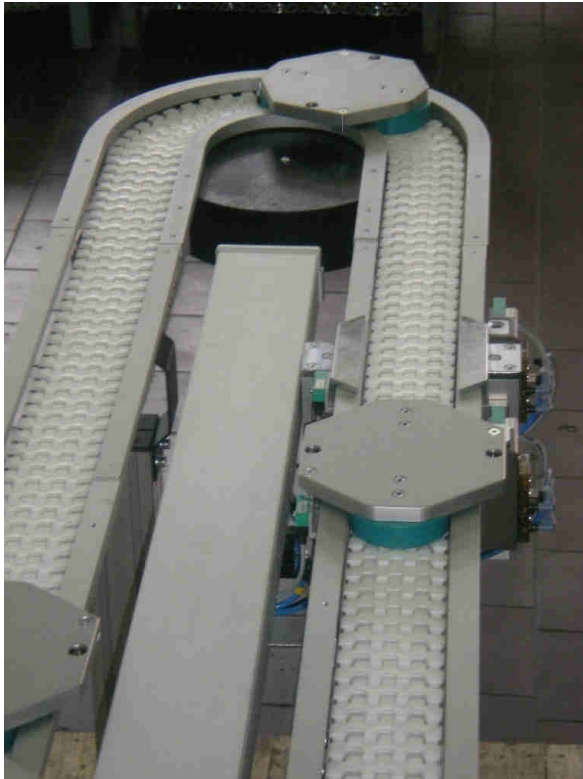

## FS- diverse Industriezweige



## Kunden aus diversen Industriezweigen:





## FS Solutions- innovativ, flexibel und zuverlässig

✓ Langjährige Erfahrung in unterschiedlichen Industriezweigen

✓ Schlüsselfertige Transportanlagen,  
montierte Förderer oder Komponenten-  
ganz nach Ihren Wünschen.

✓ After Sales Service:  
Unser Qualitätsversprechen geht weit  
über die termingerechte Lieferung hinaus

✓ Erfahrene Projektingenieure unterstützen  
bei Ihren individuellen Anforderungen



Fragen?

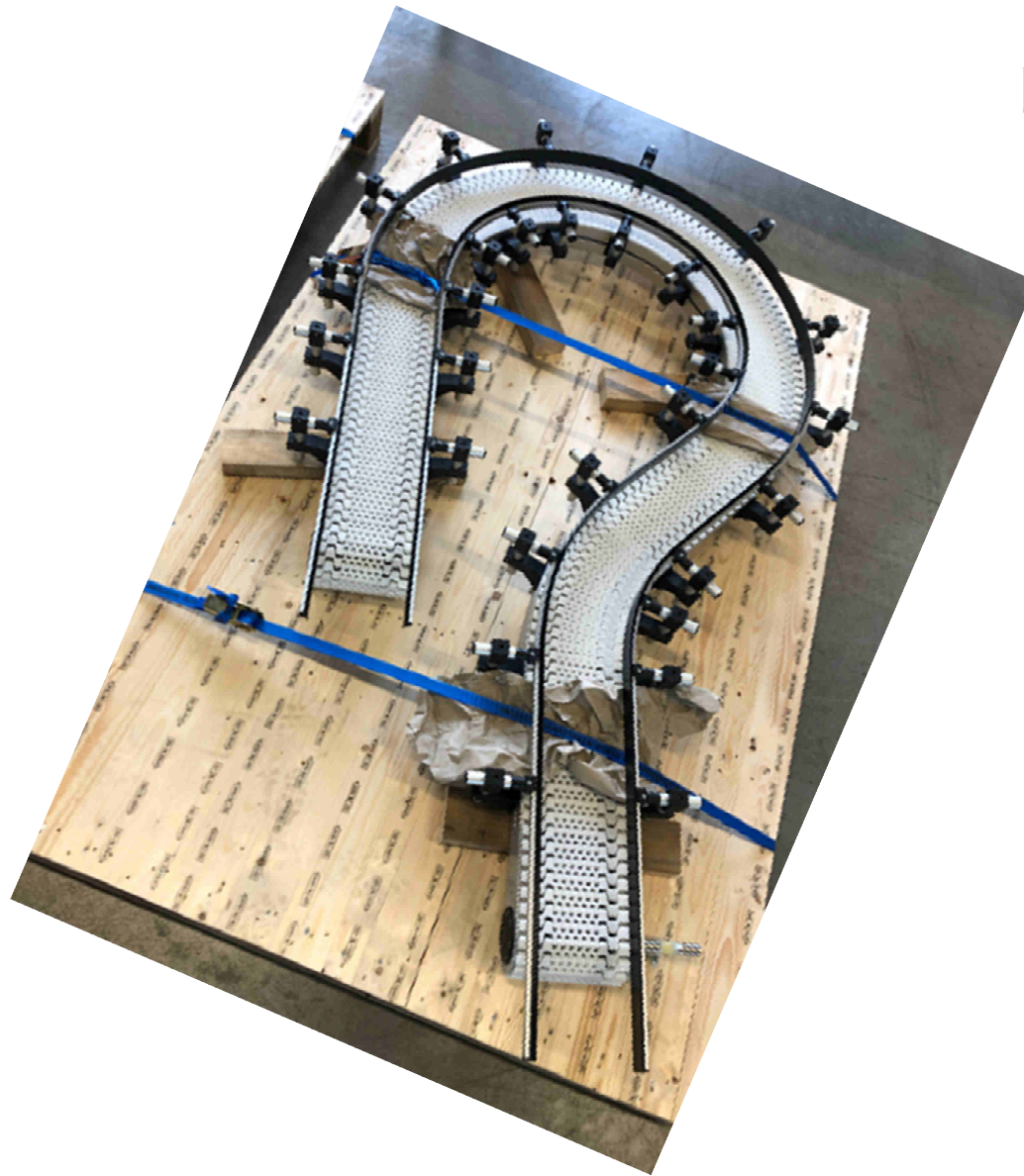

**FS Solutions**  
The best in flexible transportsystems



Herzlichen Dank!

The best in flexible transportsystems